













INSTALLATION INSTRUCTION

KM-1800

Parts List

Please check the parts in the package in comparison with the following list, make sure all of the parts are in the package. Never use defective parts; never replace part with different specification.

| | | | | | |
|---|---|-------------|---|---|---------|
| A |  | 1 | F |  | 10mm-4 |
| |  | 8mm-1 | G |  | M8x25-4 |
| B |  | M6x60-2 | H |  | M6x25-4 |
| |  | M5x10-4 | I |  | M8x70-4 |
| C |  | M6x10-2 | J |  | M8x70-4 |
| D |  | M8x1.2mm-20 | K |  | M8x40-8 |
| E |  | 8mm-8 | | | |

3. Installation and operation instructions

Note: please read the instructions carefully before installation!

STEP-1

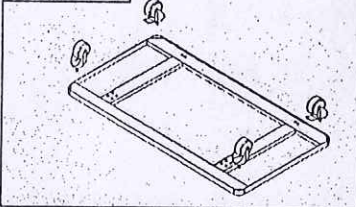

Step 1:
Tighten the four wheels through the washer to the base.

STEP-2

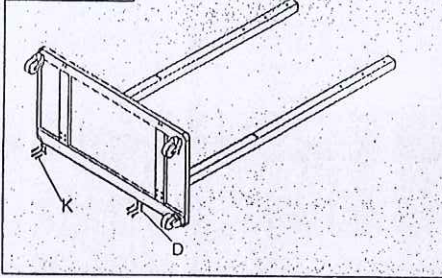

Step 2:
Insert the tubes into the base and tighten the screw.

STEP-3

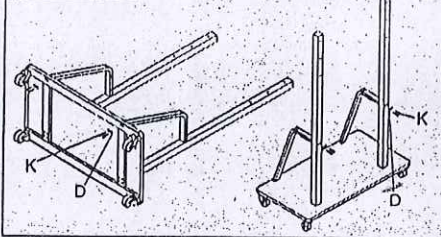

Step 3:
Assemble two panels.

STEP-4

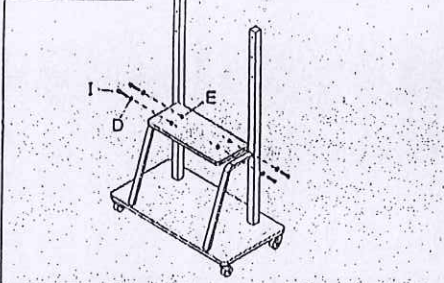

Step 4:
Install the DVD tray.

STEP-5

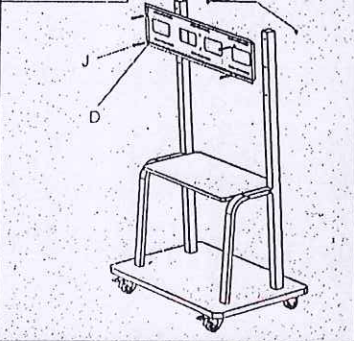

Step 5:
Install the TV plate.

STEP-6

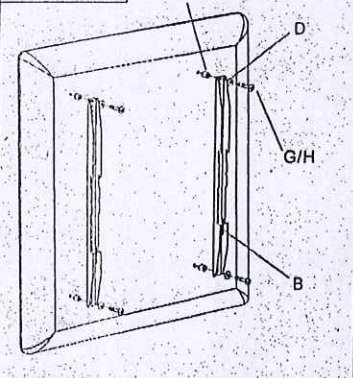

Step 6:
Install the TV bracket onto the back of the TV.

STEP-7

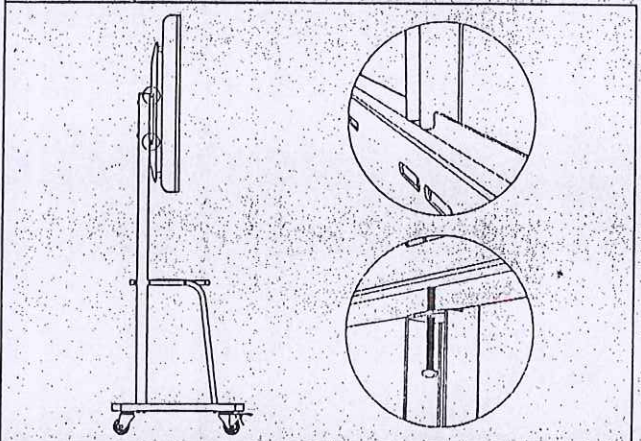

Step 7:
Hang the TV onto the TV plate.

STEP-8

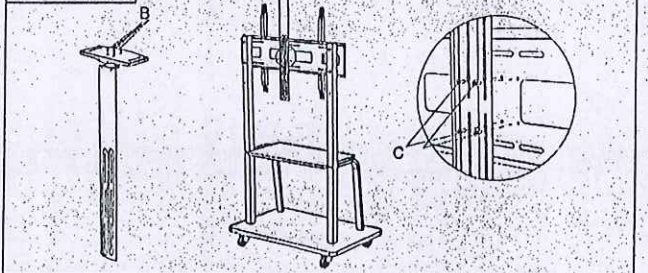

Step 8:
Install the camera assembly.
The camera assembly is installed behind the TV plate.