

PRODUCT SPECIFICATIONS

Model		DW-60W138	DW-60W258	DW-60W388	
Technical Data	Cabinet Type	Chest	Chest	Chest	
	Climate Class	N	N	N	
	Cooling Type	Direct cooling	Direct cooling	Direct cooling	
	Refrigerant	R600a/R1150	R600a/R1150	R600a/R1150	
	Sound Level((dB(A))	43	43	43	
Performance	Cooling performance(°C)	-60	-60	-60	
	Temperature Range(°C)	-30 ~ -60	-30 ~ -60	-30 ~ -60	
Control	Controller	Microprocessor	Microprocessor	Microprocessor	
	Display	LED	LED	LED	
Electrical Data	Power Supply (V/Hz)	220 ~ 240/50	220 ~ 240/50	220 ~ 240/50	
	Power (W)	370	410	420	
	Electrical Current (A)	3	3	3.5	
Dimension	Capacity(L/Cu.Ft)	138/4.9	258/9.1	388/13.7	
	Net/Gross Weight (approx)	kg	62/75	88/108	105/130
		lbs	137/165	194/238	232/287
	Interior Dimension(W*D*H)	mm	580*445*620	1000*445*620	1450*445*620
		in	22.8*17.5*24.4	39.4*17.5*24.4	57.1*17.5*24.4
	Exterior Dimensions (W*D*H)	mm	790*770*950	1210*770*950	1655*770*950
		in	31.1*30.3*37.4	47.6*30.3*37.4	65.2*30.3*37.4
	Packing Dimensions (W*D*H)	mm	815*800*990	1255*800*990	1695*800*990
		in	32.1*31.5*39	49.4*31.5*39	66.7*31.5*39
	Container Load(20'/40'/40'H)		28/56/56	22/46/46	14/28/28
Alarms	High/Low Temp	Y	Y	Y	
	Sensor Error	Y	Y	Y	
	Power Failure	Y	Y	Y	
	Remote Alarm	Y	Y	Y	
Accessories	Caster	Y	Y	Y	
	Porthole	Y	Y	Y	
Others	Certification	CE	CE	CE	

# -60°C Freezer



DW-60W138



-60°C rapid freezing process powered by innovative ultra-low temperature system.



Super low sound operation: noise cancelling technology yields a sound level of less than 43 dba.



Multiple alarm system includes temperature alarms, sensor error alarm, power failure alarm and remote alarm



HC refrigerant system is optimized to improve refrigeration efficiency by 30 %, and save energy by about 50%.

The Product is designed to store virus, bacteria, red blood cells, white blood cells, skin, bones, semen, biological products, ocean-going supplies and electronic devices, as well as to provide a low-temperature environment for testing of special materials. These units are installed in hospitals, blood stations, diseases prevention & control centers, research institutions, bioscience laboratories, and medical laboratories.

発売元

株式会社ビットstrong 画像営業部  
<https://www.bitstrong.co.jp/>  
 東京都文京区小石川2-25-16 パーソナルハウス 2F  
 TEL:03-3868-5605 FAX:03-3868-5616  
 担当: 中村、藤野  
 また下記Webフォーム  
<https://www.bitstrong.co.jp/contact/>  
 お問い合わせはこちらから  
[imaging@bitstrong.co.jp](mailto:imaging@bitstrong.co.jp)

## Safer by Design

Single compressor auto cascade refrigeration system provides high efficient cooling power. Insulation thickness is 100 mm for optimal protection of cold temperature and saving energy.

 Creative dual seals design retains cold temperature more effectively, and eliminates condensation on gaskets.

 Stainless steel inner cabinet for easy cleaning

 Interior lock design ensures product safety. Lockable casters permit ease of installation and maneuvering.

 Water proof digital control delivers precise temperature for storage. Display and control system are easy to use.

### PRODUCT ADVANTAGES



Dual-seal design

Imported brand fan

Imported brand compressor

Digital temperature control display

### DW-60W138 | TYPICAL PERFORMANCE CHARACTERISTICS IN 25°C AMBIENT

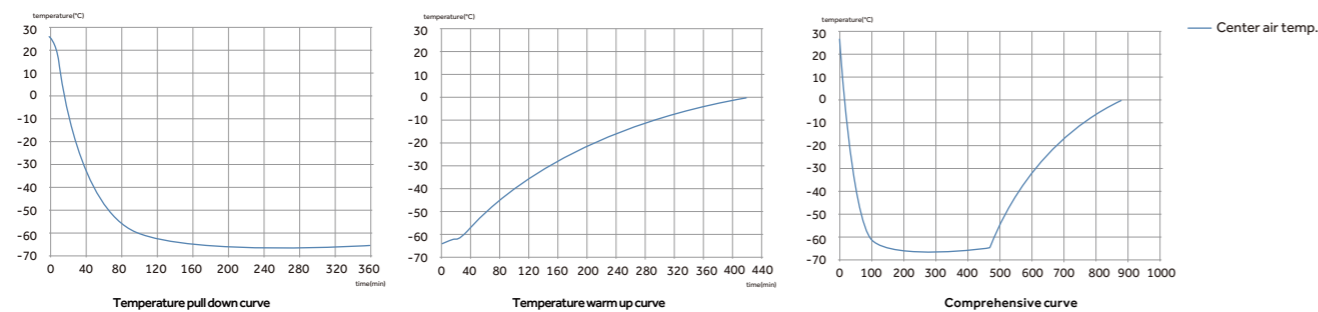

### DW-60W258 | TYPICAL PERFORMANCE CHARACTERISTICS IN 25°C AMBIENT

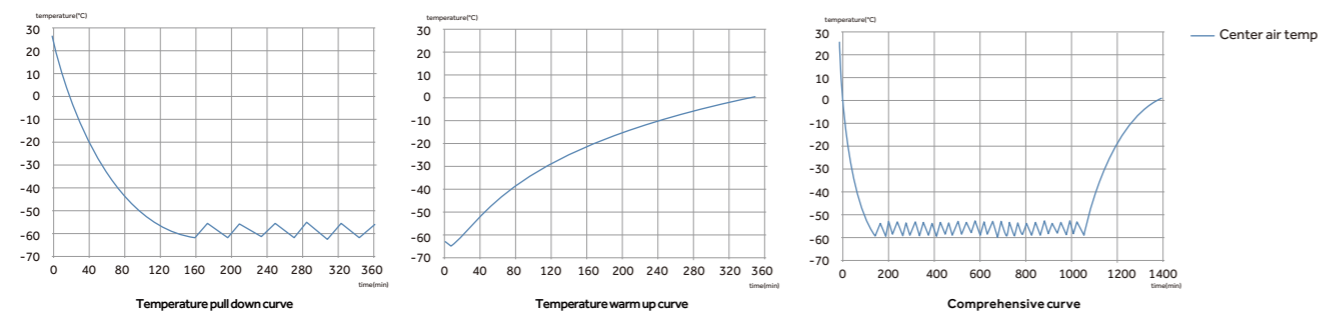

### DW-60W388 | TYPICAL PERFORMANCE CHARACTERISTICS IN 25°C AMBIENT

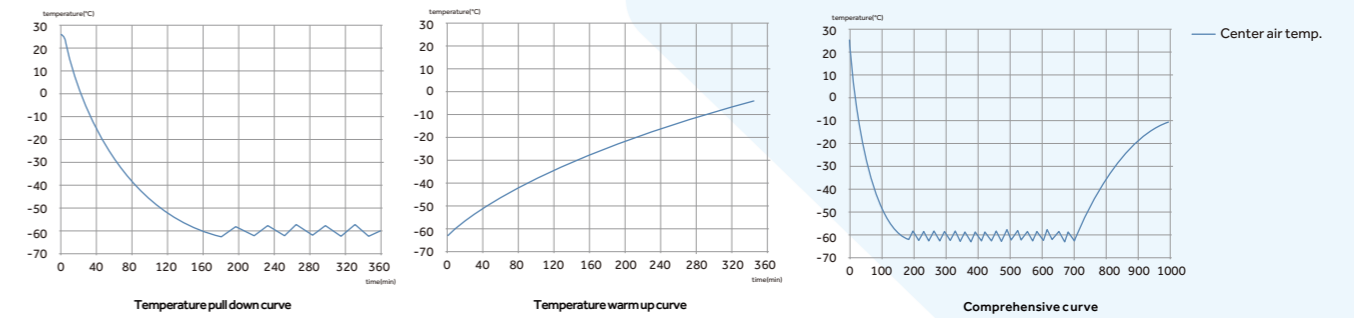

### PRODUCT DIMENSION DRAWING

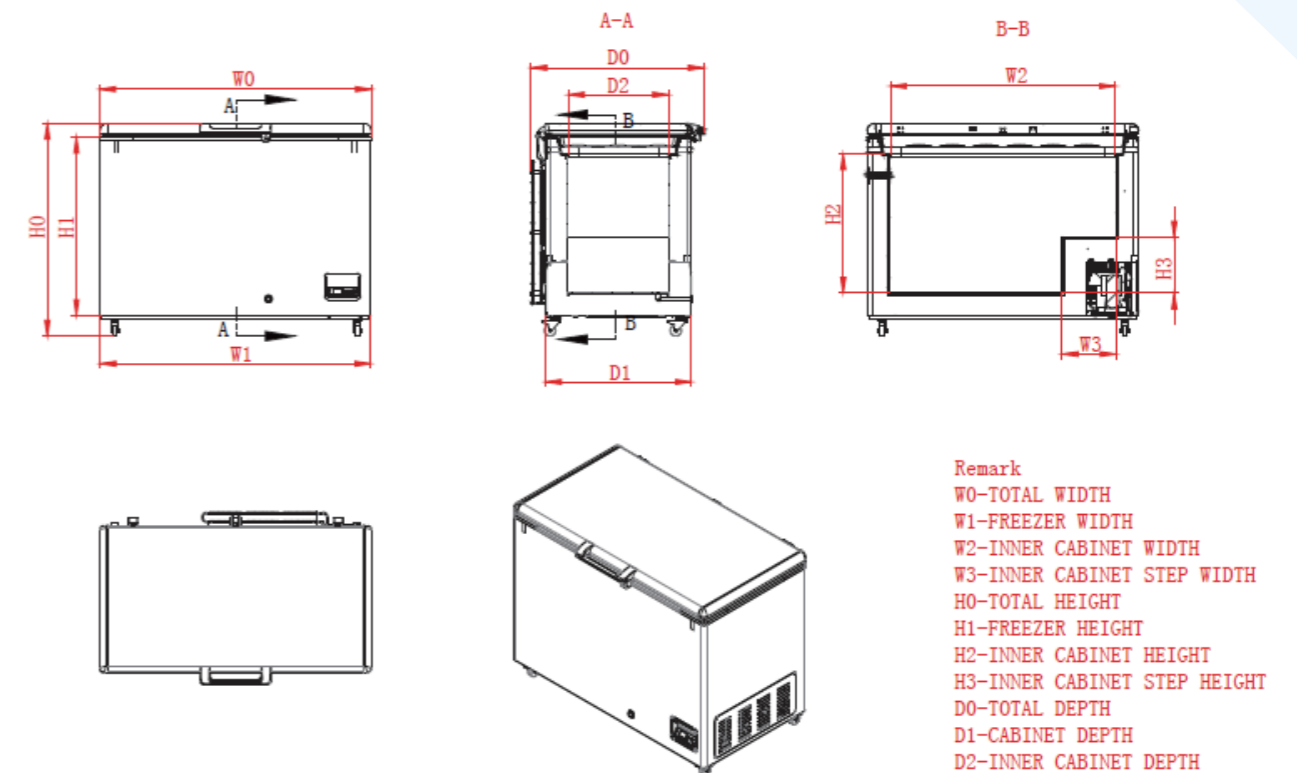

MODEL	CODE	W0	W1	W2	W3	H0	H1	H2	H3	D0	D1	D2
DW-60W138		790	785	580	240	950	797	620	250	770	650	445
DW-60W258		1210	1205	1000	240	950	797	620	250	770	650	445
DW-60W388		1655	1650	1450	240	950	797	620	250	770	650	445